

Battery Charging Circuit

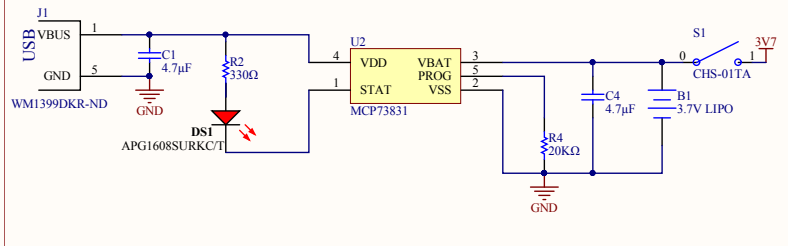

Voltage Regulation

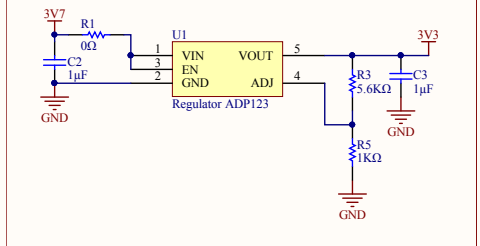

JTAG Header

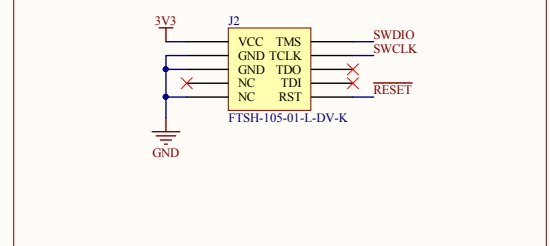

2MB Flash Memory

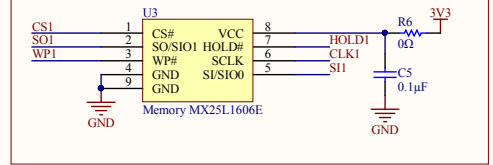

MCU

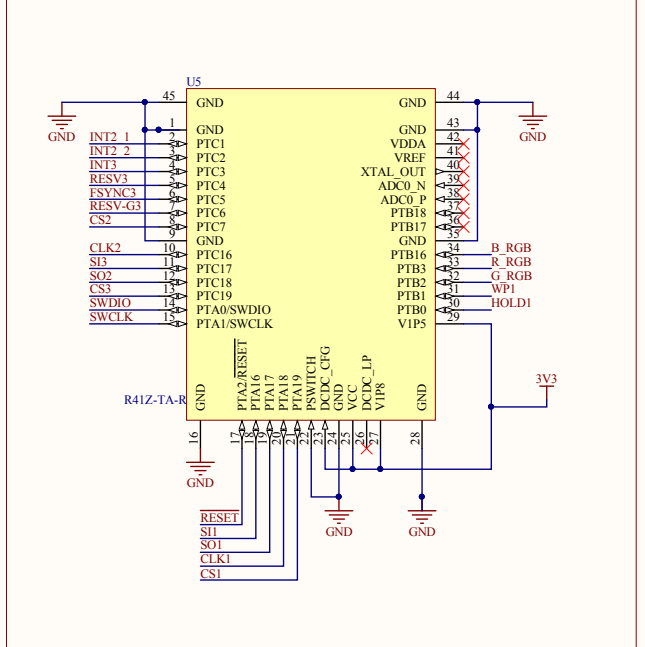

Accelerometer

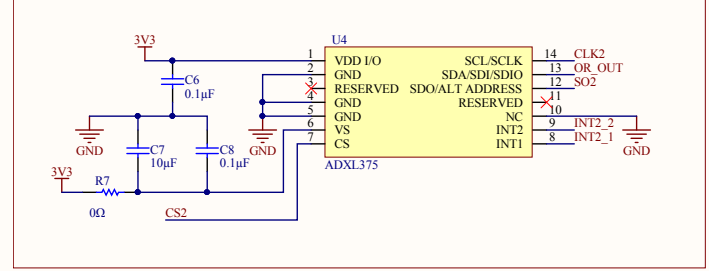

OR Gate - Preventing Bus Traffic on Accelerometer

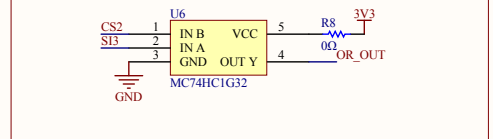

RGB LED Indicators

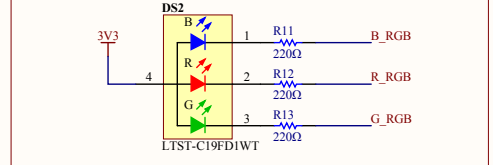

Gyroscope

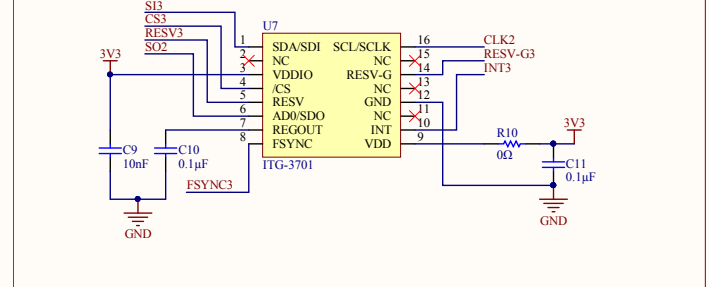

| | | |
|--------------------------------------|----------------|---|
| Project Title: Head Sense | |  |
| Sheet Title: Project Overview | | |
| Engineer: Chance Eldridge | | |
| Draftsman: Chance Eldridge | | |
| Date: 2/1/2017 | Size: B | Revision: 1.0 |
| | | Sheet: 1 of 1 |